

## Operating instructions

Pipe Cutting and  
Beveling Machine

**GFX 3.0**



Code 790 144 762

Machine no.:

Translation of original operating instructions

---

All rights reserved, in particular the rights of duplication and distribution as well as translation.  
Duplication and reproduction in any form (print, photocopy, microfilm or electronic) require the written permission of Orbitalum Tools GmbH.

# Table of contents

	Page
0 About these instructions	1
0.1 Warning messages	1
0.2 Other symbols and displays	2
0.3 Abbreviations	2
1 Safety instructions	3
1.1 Intended use	3
1.2 Improper use	3
1.3 Machine constraints	3
1.4 Safety regulations	4
1.5 Supervised operation	4
1.6 Working with safety in mind	4
1.7 Shutting down the machine	8
1.8 Waste disposal	8
1.9 Returning batteries	9
1.10 Other safety regulations	9
2 Product design	10
2.1 GFX 3.0	10
2.2 Accessories	11
2.2.1 Saw blades and bevel cutters	11
2.2.2 Stainless steel clamping attachment	11
2.2.3 Quick-mounting plate without screw clamps	12
2.2.4 Quick-mounting plate with screw clamps	12
2.2.5 Durable storage and shipping case	12
2.2.6 Saw blade lubricant GF TOP	12
2.2.7 Saw blade lubricant GF LUB	12
3 Features and scope of application	13
3.1 Features	13
3.1.1 Motor	13
3.1.2 Additional saw blade clamping point for cutting pipe elbows only	13
3.1.3 Line laser to determine cut-off point	13
3.1.4 Plug connection with quick-disconnect coupler	14
3.1.5 Tempered steel clamping jaws	14
3.2 Other outstanding features	14
3.3 Scope of application	15
3.3.1 Application range	15
4 Technical data	16
4.1 GFX 3.0	16
4.2 Line laser	16
5 Initial operation	17
5.1 Included with the machine	17
6 Storage and transport	18
6.1 Transporting the GFX 3.0	18

---

7	Preparation	19
7.1	Fitting the GFX 3.0 onto the workbench	20
7.1.1	Mounting the GFX 3.0 directly onto the workbench	20
7.1.2	Mounting the GFX 3.0 onto the quick-mounting plate <u>with</u> screw clamps	20
7.1.3	Mounting the GFX 3.0 onto the quick-mounting plate <u>without</u> screw clamps	20
7.2	Saw blade clamping point 1: Fitting the saw blade/bevel cutter	21
7.2.1	Inserting the saw blade or bevel cutter	22
7.2.2	Inserting the saw blade and additional cutter	23
7.3	Saw blade clamping point 2: Fitting the saw blade	24
7.3.1	Inserting the saw blade	24
7.4	Adjusting the pipe dimension	25
7.4.1	Setting the pipe dimension with a scale (2)	25
7.4.2	Setting the pipe dimension without a scale (2)	25
7.4.3	Setting the pipe dimension when using an additional cutter	26
8	Processing Pipes	27
8.1	Shutdown function (even in an emergency)	27
8.2	Selecting the speed levels	27
8.3	Cutting pipes	28
8.4	Beveling pipes	29
8.5	Cutting and beveling pipe simultaneously	30
8.6	Cutting pipe elbows	30
9	Maintenance	31
10	What to do if?	33
10.1	Troubleshooting	33
10.2	Servicing/customer service	33
11	EG Declaration of Conformity	34

---

# 0 About these instructions

For a quick understanding of these instructions and safe operation of the machine, all the warning messages, notes and symbols used in these instructions are presented here along with their meaning.

## 0.1 Warning messages

In these instructions, warning messages are used to warn you against the dangers of injury or material damage. Always read and observe these warning messages!



This is a warning symbol. It warns you about dangers of injury. Please follow all instructions marked with the safety symbol in order to avoid injuries or death.

Warning symbol	Meaning
 <b>DANGER</b>	Imminent danger! Non-observance could result in death or serious injury. ⊙ Restrictions (if applicable). ► Risk-prevention measures.
 <b>WARNING</b>	Possible danger! Non-observance could result in serious injury. ⊙ Restrictions (if applicable). ► Risk-prevention measures.
 <b>ATTENTION</b>	Dangerous situation! Non-observance could result in minor injuries.
<b>ATTENTION</b>	Dangerous situation! Non-observance could result in material damage.

## 0.2 Other symbols and displays

Symbol	Meaning
<b>Important Note</b>	Notes: contain particularly important information to clarify information.
	Instruction: you must take note of this symbol.
	Request for action in a sequence of actions: you have to take action in this case.
▶	Single request for action: you have to take action in this case.
▷	Conditional request for action: you have to take action if the specified condition is met.

## 0.3 Abbreviations

Abbr.	Meaning
GFX 3.0	Pipe cutting and beveling machine, type GFX 3.0

**Important**    **Warning: when using electrical tools, the following basic safety measures need to be observed to prevent electric shock, injury or fire. Read all these instructions before using this electrical tool and keep them in a safe place.**

# 1 Safety instructions

The pipe cutting and beveling machine (hereafter referred to as GFX 3.0) is a state-of-the-art machine. Using this machine in a way other than that described in this manual can lead to personal injuries to the user or of third parties. It may also damage the machine or other equipment.

Therefore:

- always ensure that the machine is in good working order.
- Comply with these safety instructions.
- Keep complete documentation close by the machine.
- Generally valid regulations for the prevention of accidents must be observed.

## 1.1 Intended use

- The GFX 3.0 is only to be used for processing (cutting and beveling) metallic pipes and pipe ends up to 3 inches (78 mm). The machine should only be used on empty, deenergized pipes. Temperature range: -15 °C to 40 °C.

## 1.2 Improper use

- The machine is not intended for use by private consumers. Do not use the machine on energized piping, in explosive atmospheres or on contaminated pipes.
- Do not use the machine outdoors when it is foggy, raining, during a thunderstorm or when the relative humidity > 80% (measured at 20°C). Do not use the GFX 3.0 as a drive for applications other than those listed under proper use (see chap. 1.1).

## 1.3 Machine constraints

- Space requirement/freedom of movement: A radial space of approx. 1 m around the machine is required for people.
- Work lighting: min. 300 lux.
- Minimum age of operator: 14 years.

**DANGER**

---

### **Safety components that are contaminated or worn are defective!**

The failure of safety components can cause physical injury.

- ▶ Check defective safety components daily to ensure proper operation.
  - ▶ Clean and maintain the machine every day.
  - ⊙ **Do not** misuse the cable, e.g. such as using it to suspend or carry the machine.
  - ▶ Keep cables away from heat, oil, sharp edges and moving equipment parts.
  - ▶ Inspect machine daily for visible signs of damage or defects and have repaired by a specialist if necessary.
- 

## **1.4 Safety regulations**

- Only use the dimensions and materials specified in these instructions. Other materials should be used only after consulting with Orbitalum Tools customer service.
- Use only original Orbitalum Tools spare parts and materials.
- Repair and maintenance work on the electrical equipment may only be carried out by a qualified electrician.
- Before changing tools, transportation, carrying out any maintenance, repairs or adjustments, switch the machine off and let it run to a stop.
- Only operate the GFX 3.0 if all safety equipment, such as the restart inhibitor, overload protection and saw blade guard, is working and the pipe cutter is fitted to the vice and mounting plate.
- Flex rotating cable: only approved for double-insulated cutter motor, protection class II.

## **1.5 Supervised operation**

- Workshop application: The workshop manager is responsible for safety in the danger zone around the machine and should allow only qualified personnel to enter the zone or operate the machine.
- Outdoor/field application: The site manager is responsible for safety in the danger zone around the machine and should allow only qualified personnel to enter the zone or operate the machine.

## **1.6 Working with safety in mind**

"Make your contribution to safety in the workplace."

- Report any unusual machine behavior to the person responsible immediately.
- Be aware of safety aspects at all times when working.





- When working with the GFX 3.0, wear safety shoes in accordance with EN ISO 20345 S3, safety goggles in accordance with DIN EN 166, safety gloves in accordance with EN 388 and ear protection in accordance with DIN EN 352. **Note:** The recommendations concerning "Personal protective equipment" only apply to the product being described. Other requirements resulting from the ambient conditions on-site or of other products, or from combining with other products, are not taken into account. These recommendations do not in any way release the operating company (employer) from its statutory health and safety at work obligations towards its employees.
- Tie up long hair (hairnet); **do not** wear loose-fitting clothes, jewelry or ties as they can get caught in the rotating parts.
- After each work process, switch off the machine and let it run to a stop.
- Before changing tools, cleaning or performing any maintenance, adjustment or repair work, pull the GFX 3.0 mains plug and allow the machine to run to a stop.
- During operation, keep hands away from the tools.
- Check that the work piece is correctly clamped.
- Switch on the machine only when the pipe has been clamped.
- Fault current (FI) protection in the mains supply line is required and must be provided by the customer.
- Do not carry the electric tool by the cable and do not use the electric tool to pull out the plug. Protect the cable from heat, oil and sharp edges (chips).
- Keep the GFX 3.0 dry, do not use in the rain.
- Do not operate the GFX 3.0 in hazardous areas.

**DANGER**

---

### **Danger of death by electric shock!**

If the mains cable is damaged, live parts may cause death if touched directly.

- ⊙ Keep the mains cable of the pipe cutter motor **away** from the saw blade or cutting tool.
- ⊙ Do **not** let the cut-off pipe piece drop in an uncontrolled manner.
- ⊙ Do **not** run the machine unattended.
- ▶ Secure the falling pipe piece.
- ▶ During processing, always keep an eye on the position of the mains cable.
- ▶ Keep the machine clean. Always remove lubricant residues from the machine.

**DANGER**

---

### **Damaged insulation!**

Fatal electric shock.

- ⊙ **Do not** screw any indicators or signs to the electric tool.
  - ▶ Use stickers.
-

**DANGER****Metal dust can collect in the housing and cause loss of insulation!**

Fatal electric shock.

- ▶ Depending on the level of contamination, clean the machine at least once a day using the brush supplied.

**DANGER****Electric shock from damaged plugs!**

Fatal.

- ▶ The machine connector plug must fit the socket.
- ⊗ **Do not** use adapter plugs with ground protected electrical tools.

**DANGER****Electric shock from grounded body!**

Fatal.

- ⊗ **Avoid** contact with grounded surfaces such as pipes, heaters, stoves or ice boxes.

**WARNING****Machine noise levels can be > 80 dB (L<sub>aeq</sub> [dB(A)])!**

Irreversible damage to hearing.

- ▶ Wear ear protection that complies with DIN EN 352.

**WARNING****Parts can be ejected when working!**

Irreversible eye injuries.

- ▶ Wear safety goggles that comply with DIN EN 166.
- ▶ Make sure saw blade guard works.

**WARNING****Falling objects!**

Irreversible crushing of feet.

- ▶ Wear protective shoes that comply with DIN EN 20345-S3.

**WARNING****Loose clothing and long hair can get caught in the machine!**

- ⊗ During operation, **do not** wear loose clothing, e.g. neckties.
- ▶ Tie up long hair to prevent it from being caught.

**WARNING**

---

**Danger caused by unergonomic, monotonous work!**

Discomfort, tiredness and a reduced ability to react.

Limited ability to react, and cramps.

- ▶ Do relaxation exercises.
  - ▶ Ensure activity is varied.
  - ▶ Assume an upright and relaxed posture when working.
- 

**WARNING**

---

**Flying, hot and sharp-edged chips!**

Danger of damage to eyes and hands.

- ⊘ Do **not** touch the revolving blade whilst the machine is in operation.
  - ⊘ **Never** work without the saw blade guard mounted.
  - ▶ Always wear protective goggles, safety shoes and safety gloves.
  - ▶ Make sure saw blade guard works.
  - ▶ Remove chips only with safety gloves.
- 

**WARNING**

---

**Pressing the ON-OFF switch unintentionally!**

- ▶ The machine may only be operated using a fault current (FI) protect switch.
  - ▶ Before replacing tools, cleaning or performing any maintenance, adjustment or repair work, pull the mains plug and allow the machine to run to a stop.
- 

**WARNING**

---

**Danger of being injured by sharp cutting edges!**

- ⊘ Keep hands **away** from the tools during cutting or beveling.
  - ▶ Wear safety gloves.
  - ▶ Use the pipe cutter only when the pipe has been clamped.
  - ▶ Make sure saw blade guard works.
  - ▶ Do not remove any scrap or portion of the work piece from the cutting area while the machine is running or before the cutting unit has come to a complete stop.
-

**WARNING****Danger of being injured by laser radiation!**

Failure to take due care can result in the retina of the eyes being damaged and can thereby impair sight.

- ⊙ Do **not** look at the laser beam or view using optical instruments.
- ⊙ Do **not** point the laser beam at other people.
- ▶ Do **not** misuse the line laser and do **not** remove from the pipe cutter.

**WARNING****Danger of being injured by uncontrolled, rotating slide housing and pipe!**

Care should be taken to ensure that the cutting blade is not touching the pipe when the machine is started, as this will send the slide housing (head) around the pipe in an uncontrolled manner.

- ▶ Make sure that the slide housing is in the home position when the cutting process starts.
- ▶ Clamp the pipe to be cut into the vice.
- ▶ Pull off the hand wheel from the spindle before the slide housing starts rotating.
- ⊙ In their home position, the saw blade or bevel cutter may **not** touch the pipe!
- ▶ Before switching the motor on, make sure that the gap between the saw blade/bevel cutter and the pipe is sufficient and that the pipe is securely clamped in the vice.
- ▶ Place the pipe holders underneath the pipe, see chap. 8.3, p. 28.

## 1.7 Shutting down the machine

For more information about the shutting down function, see chap. 8.1, p. 27.

## 1.8 Waste disposal

- Dispose of chips and used gear lubricant oil according to the regulations.

**Discarded electrical tools and accessories contain large quantities of valuable raw and synthetic materials that can be recycled. Therefore:**

- Electrical (electronic) devices that are marked with the symbol to the left may not be disposed of with household waste in accordance with EU regulations.
- By actively using the available return and collection systems, you contribute to the reuse, recycling and utilization of electrical (electronic) devices.
- Used electrical (electronic) devices contain parts that must be handled selectively according to EU regulations. Separate collection and selective treatment is the basis for environment-friendly disposal and the protection of human health.



(as per RL 2002/96/EC)

- Appliances and products that you bought from us after August 13, 2005 will be disposed of at no cost in accordance with legal standards after they have been supplied to us.
- We may refuse to accept old appliances that pose a risk to human health or safety due to contamination produced during use.
- The end user is responsible for disposing of used appliances introduced to the market before August 13, 2005. Please contact a disposal center near you for this purpose.
- **Important for Germany:** our products may not be disposed of in municipal disposal sites as they are only used for industrial purposes.

## 1.9 Returning batteries



Some of our units are battery-powered.

- Accumulators and batteries that are marked with one of the symbols to the left may not be disposed of with household garbage according to EU directive 91/157/EEC.
- In batteries containing harmful substances, the chemical sign for the heavy metal contained is indicated below the garbage can:  
Cd = Cadmium    Hg = Mercury    Pb = Lead
- **Valid for Germany:** the end user is required to return defective or used batteries to the distributor or to a recycling center established for the purpose.

## 1.10 Other safety regulations

Observe country-specific regulations, standards and guidelines.

## 2 Product design

### 2.1 GFX 3.0

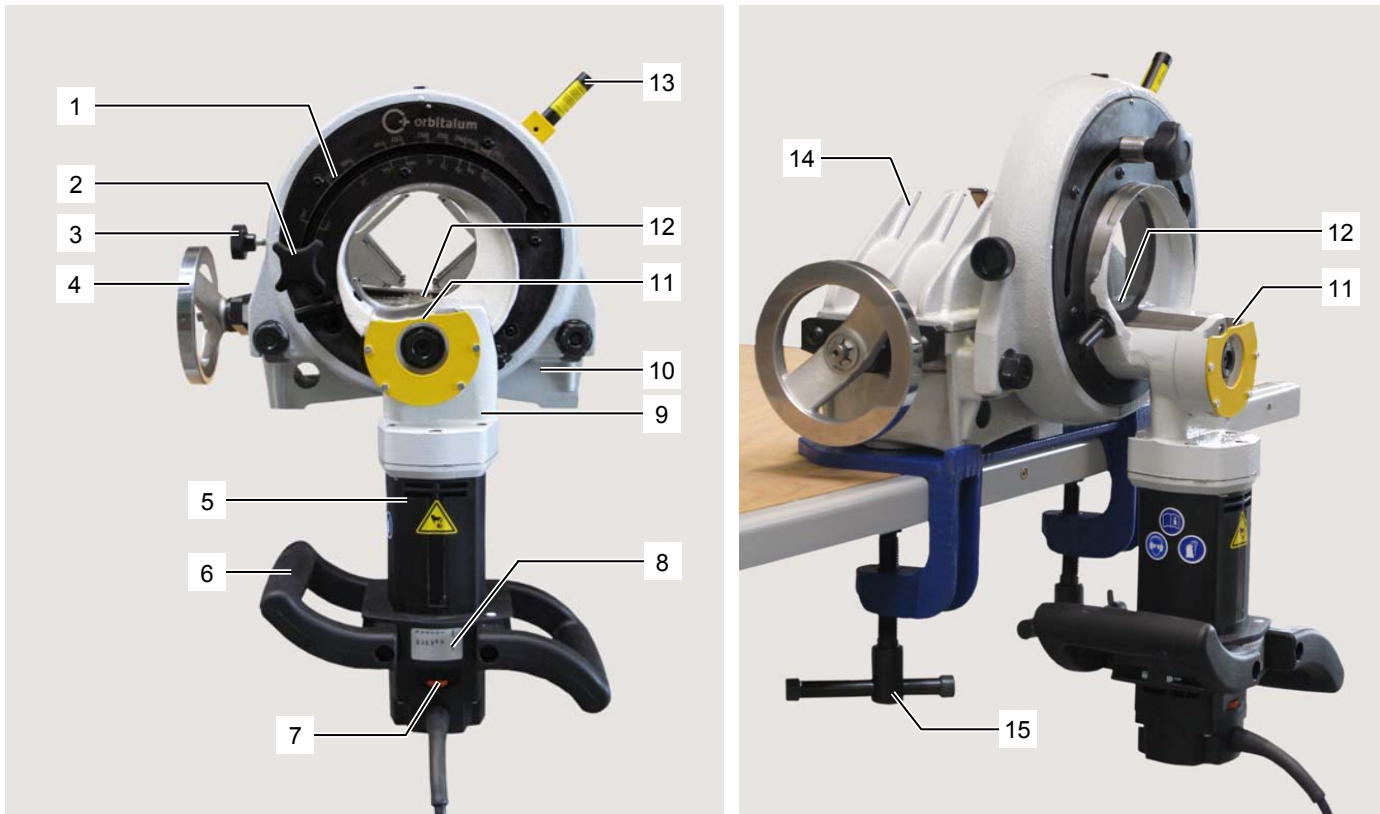

- 1 Scale for adjusting the pipe dimension
- 2 Star knob for setting the pipe dimension
- 3 Locking screw
- 4 Hand wheel for clamping jaws
- 5 Motor (details, see chap. 3.1.1, p. 13)
- 6 Handle
- 7 RPM regulator
- 8 Speed adjustment
- 9 Slide housing
- 10 Vice
- 11 Saw blade clamping point 2 (for cutting pipe elbows)
- 12 Saw blade clamping point 1
- 13 Line laser (details, see chap. 3.1.3, p. 13)
- 14 Cast steel clamping jaws
- 15 Quick-mounting plates with screw clamps (available as an option, see chap. 2.2.4, p. 12)

## 2.2 Accessories

Not included with machine, but can be ordered separately.



### Danger caused by insufficiently safe accessories!

Diverse physical injuries.

- ▶ Use only accessories that have been specifically developed and approved by the manufacturer.

### 2.2.1 Saw blades and bevel cutters



All saw blades and bevel cutters by Orbitalum Tools are specially developed for our pipe cutters to endure maximum strain and have a maximum tool life. A selection of 4 different saw blades and bevel cutters are available for various uses:

- **Economy Range** for low and non-alloy steels and cast iron pipes
- **Performance Range** for high-alloy steels (stainless steel)
- **High Performance Range** for high-performance materials and high-alloy steels
- **Premium Range** especially made for stainless steel applications with extra long durability

Workable pipe materials	Al	Mild steel, Cu, CuNi, CuZn, CuSn	STAINLESS, V2A, V4A, 304, 316 (L)	Ti, Duplex, Inconel
Economy	*	*		
Performance		*	*	
High Performance		*	*	*
Premium			*	

### 2.2.2 Stainless steel clamping attachment



Ideal for processing stainless steel pipes. Avoids contact corrosion between the pipe and clamping parts. Clamping shells for thin-walled pipes available upon request.

Included:

- 6 stainless steel prismatic plates
- 12 countersunk screws
- 1 socket head key

Product	Code
Complete stainless steel clamping attachment for GFX 3.0	790 144 200



### 2.2.3 Quick-mounting plate without screw clamps



Complete with bolts and nuts to fit the bench plate to the workbench.

Product	Code
Complete quick-mounting plate for GFX 3.0, RA 2 (H), RA 21 S	<b>790 041 026</b>

### 2.2.4 Quick-mounting plate with screw clamps



To quickly fit machines to workbenches. Ideal if changing location often.

Product	Code
Quick-mounting plate for GFX 3.0, RA 2 (H), RA 21 S	<b>790 041 027</b>

### 2.2.5 Durable storage and shipping case



High quality padded blue shipping case. Particularly sturdy design.

Product	Code
Hard shell transportation case for GFX 3.0	<b>790 144 019</b>

### 2.2.6 Saw blade lubricant GF TOP



Synthetic high-performance lubricant for cutting and beveling machines. Increases the tool life of the saw blade. Registered according to the NSF H2 food approval. The screwable brush guarantees an easy and uniform application of lubricant on the saw blade.

Product	Code
Saw blade lubricant GF TOP	<b>790 060 228</b>

### 2.2.7 Saw blade lubricant GF LUB



For cutting and beveling. Increases the tool life of the saw blade. The new ecological lubricant is the environmentally-friendly successor to ROCOL; with a new name and improved quality. GF LUB complies with the latest environmental guidelines and ecological standards. The chlorine-free GF LUB can be ordered using the same article number as the previous lubricant, ROCOL.

Product	Code
Saw blade lubricant GF LUB, Tube, 160 ml	<b>790 041 016</b>



## 3 Features and scope of application

### 3.1 Features

The GFX 3.0 pipe cutting and beveling machine is distinguished by the following characteristics:

#### 3.1.1 Motor

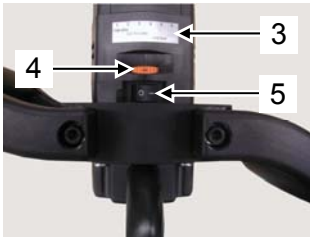

Motor

With built-in variable cutting speed and ergonomic handles. Enables a safer operating position and cutting of pipe elbows without alteration.

#### Other advantages:

- Electronic overload protection with integrated temperature monitor and speed control.
- A restart inhibit function prevents the machine from starting in an uncontrolled way after it has been re-connected to the electric mains or after the voltage supply has been re-established following a power failure.
- High performance drive (1200 W) with adjustable speed range for cutting a selection of materials.
- Increased blade life.
- Rotating-speed indicator (3) for speed selection.
- Ergonomically positioned speed adjustment wheel (4) and ON/OFF switch (5).

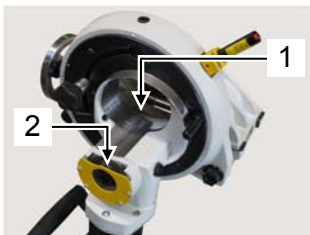

Saw blade clamping points

#### 3.1.2 Additional saw blade clamping point for cutting pipe elbows only

Which saw blade clamping point to use?

Saw blade clamping point 1	Saw blade clamping point 2
Cutting pipes	Cutting pipe elbows only

#### 3.1.3 Line laser to determine cut-off point

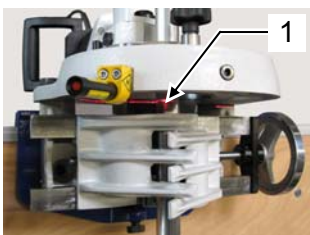

Line Laser

To determine the cut-off point on the pipe. Ideal for checking whether the pipe is adjusted to the desired cut-off point. A red line marking (1), to determine the cut-off point, appears on the clamped pipe once the red button on the laser pointer has been actuated. If necessary, the pipe position can be corrected until the desired cut-off point is marked.

**WARNUNG****Danger of being injured by laser radiation!**

Failure to take due care can result in the retina of the eyes being damaged and can thereby impair sight.

- ⊘ Do **not** look at the laser beam or view using optical instruments.
- ⊘ Do **not** point the laser beam at other people.
- ▶ Do **not** misuse the line laser and do **not** remove from the pipe cutter.

**3.1.4 Plug connection with quick-disconnect coupler***Flex rotating cable*

For easy and comfortable replacement of the power cable. Also prevents twisting of the cable.

**Other advantages:**

- If there is a cable fracture, then the cutter motor does not have to be opened and a qualified electrician is not required to replace the flex cable.
- As the flex cable is locked away, misuse can be prevented.

**3.1.5 Tempered steel clamping jaws***Cast steel clamping jaws*

The GFX 3.0 is fitted with tempered cast steel clamping jaws as standard. A stainless steel clamping attachment is available as an option (see chap. 2.2.2, p. 11). The 6 stainless steel prismatic plates are fitted quickly and easily onto the cast steel clamping jaws to prevent any possible contact corrosion between the pipe and clamping jaw. Clamping shells for thin-walled pipes available upon request.

**3.2 Other outstanding features***Stainless steel clamping attachment*

- Enhanced safety due to stationary pipe and rotating tool.
- Self-centering vice.
- Right-angled, burr-free cutting surface and deformation-free pipe cross-section.
- Production of standardized welding bevels.
- Cold machining process.
- Quick cutting process.
- Quick tool change.
- Easy assembly and little space required.
- Simultaneous cutting and beveling of thin-walled metal pipes.
- Working without getting tired when cutting and beveling pipes with larger pipe dimensions and thicker walls.
- Optimized discharge of chips thanks to the design of the vice.

- Environmentally friendly.
- Long service life.
- Lightweight, so easy to handle.
- Increased productivity.
- Low and easy maintenance.

### 3.3 Scope of application

#### 3.3.1 Application range

Material	Pipe OD (min. - max.)		Saw blade Ø		Wall thickness (min. - max.)	
	[mm]	[inch]	[mm]	[inch]	[mm]	[inch]
Pipes / Pipe elbows	6,0 - 78,0	0.236 - 3.071	63	2.480	0,8 - 5,5	0.032 - 0.217
	6,0 - 73,0	0.236 - 2.874	68	2.677	0,8 - 7,0	0.032 - 0.276
Cylindrical solid material	6,0 - 16,0	0.236 - 0.630	63	2.480	–	–
	6,0 - 21,0	0.236 - 0.827	68	2.677	–	–
Pipe materials	Unalloyed, low-alloy und high-alloy steel, stainless steel, non-ferrous metal, aluminum alloys, titanium alloys, composites and plastic					

## 4 Technical data

### 4.1 GFX 3.0

Dimensions	570 x 280 x 330 mm 22.44 x 11.02 x 12.99 inch
Weight incl. vice, without clamping shells	28.10 kg 62.04 lbs
Power	1200 W
Protection class	II
Built-in electronic variable cutting speed with restart inhibitor	30 - 200 rpm
Versions (1-phase AC)	230 V, 50/60 Hz EU 120 V, 50/60 Hz US
Vibration level as per EN 50144	< 2.5 m/s <sup>2</sup>
Sound pressure level at the workplace <sup>*)</sup>	79.7 dB (A)

<sup>\*)</sup> The noise level was measured under normal operating conditions in accordance with EN 23741.

### 4.2 Line laser

Operating voltage	2.8 to 4.5 V DC
Operating current	20 mA
Laser class	1
Battery type	2 or 3 LR44/AG13

## 5 Initial operation

### Checking the parts of delivery

- ▶ Check delivery for completeness and damage caused by transport.
- ▶ Report any missing parts or damage caused by transport to your supplier immediately.



*Wide range of accessories*

### 5.1 Included with the machine

- 1 Pipe cutting and beveling machine GFX 3.0
- 1 Transport case
- 1 Saw blade (Code 790 048 072)
- 1 Tool key set
- 1 Tube of saw blade lubricant GF TOP (Code 790 060 228)
- 1 Set of operating instructions and spare parts list

Subject to change.

## 6 Storage and transport



### Danger of death by electric shock!

- ▶ Before transport, assembly and/or disassembly of the GFX 3.0, disconnect the power supply and wait until the machine and tool have come to a full stop.



### Heavy weight during transport of the GFX 3.0 (28.1 kg, with crate 36 kg)!

Danger of being injured through overstraining.

- ⊙ **Never** carry and assemble the pipe cutter alone.
- ▶ Transport and assemble the pipe cutter with the help of a crane or a similar lifting device.
- ▶ Wear safety gloves.



### Incorrect machine storage!

Diverse risks.

- ▶ Store the machine in its original crate in a dry environment.

For secure transportation, handle the machine as shown below.

### 6.1 Transporting the GFX 3.0

1. Clamp an appropriate pipe that is adequately long in the center of the vice.
2. Place the transport straps on both sides around the pipe.
3. Lift the cutter by the straps and mount directly onto the workbench or insert in the assembled quick-mounting plate on the side (fit quick-mounting plate, see chap. 7.1).



*GFX 3.0 position of crate*

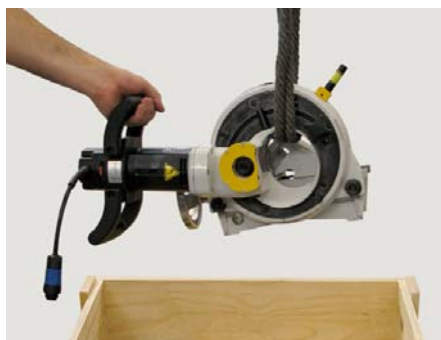

*GFX 3.0 removal from crate*



*GFX 3.0 transport*

## 7 Preparation



### Danger of death by electric shock!

- ▶ Prior to assembly, dismantling, maintenance and adjustment work, disconnect the GFX 3.0 from the power supply and let it come to a complete stop.



### Electric shock due to shunting of armature shaft isolation!

Danger of death.

- ⊗ **Do not** connect anything other than the stipulated safety equipment between the socket and the machine.
- ▶ Connect a ground-fault circuit interrupter.



### Danger of being injured by flying parts or breaking tool!

- ⊗ Do **not** process the pipe while it is loose in the vice.
- ⊗ **Never** use a damaged or deformed saw blade or cutter.
- ▶ Clamp the pipe to be cut into the vice.
- ▶ Immediately replace worn-out tools.
- ▶ Ensure that the cutting tools are correctly fitted.
- ▶ Pipe diameter must be set correctly. During cutting, the saw blade must cut through the entire pipe wall thickness.



### Restart of machine following blockage!

Injuries to body.

- ▶ In the event of a blockage, always disconnect the machine from the power supply before clearing it.



### Hot pipe surface, saw blades and bevel cutters!

Danger of burning.

- ⊗ **Do not** touch the pipe surfaces and cutting edges after machining.
- ⊗ When changing the saw blade, **do not** touch the saw blade/bevel cutter and nut without wearing gloves (as per EN 388).



### Vapors when working with lubricants!

Damage to lungs, skin and the environment.

- ▶ Only use GF TOP or GF LUB lubricants.



---

### Poor lighting!

Diverse risks.

- ▶ Ensure that the lighting is at least 300/200 lux (work area/surrounding area).
- 

### Attention Tool damage

A pipe that is not sawn off at right-angles can damage the tool if the distance between the cutting edge and the pipe surface is too small.

- ▶ Before switching on the GFX 3.0, ensure that there is sufficient distance between the saw blade and the pipe surface.

## 7.1 Fitting the GFX 3.0 onto the workbench

Fit the pipe cutter to the workbench; either

- directly onto the workbench, or
- onto the quick-mounting plate without screw clamps (see ch. 2.2.3, p. 12)  
or
- onto the quick-mounting plate with screw clamps (see chap. 2.2.4, p. 12).

### 7.1.1 Mounting the GFX 3.0 directly onto the workbench

1. Mark and punch the bolt holes on the workbench. Use the GFX 3.0 as a template.
2. Drill  $\varnothing$  13 mm holes.
3. Fit the GFX 3.0 with the provided countersunk onto the workbench.

### 7.1.2 Mounting the GFX 3.0 onto the quick-mounting plate with screw clamps

1. Fit the quick-mounting plate with the screw clamps onto the workbench.
2. Guide the pipe cutter sideways onto the fitted quick-mounting plate.  
Tighten the hexagonal bolt (1).

### 7.1.3 Mounting the GFX 3.0 onto the quick-mounting plate without screw clamps

1. Mark and punch the bolt holes on the workbench. Use the quick-mounting plate as a template.
2. Drill  $\varnothing$  13 mm holes.
3. Fasten the quick-mounting plate with screws.



4. Guide the pipe cutter sideways onto the fitted quick-mounting plate. Tighten the hexagonal bolt (1).

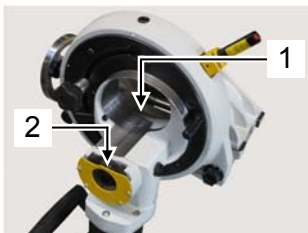
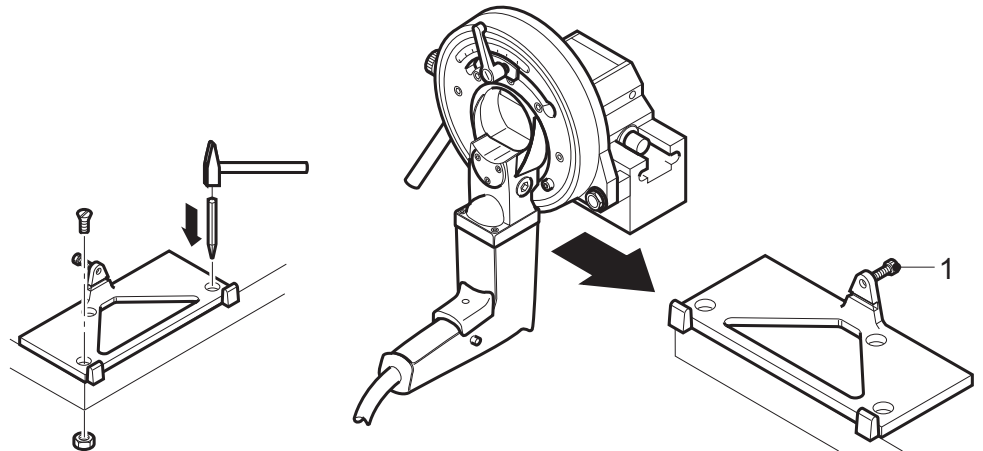

## 7.2 Saw blade clamping point 1: Fitting the saw blade/bevel cutter

Only use saw blade clamping point 1 **to cut and bevel pipes**. If you want to cutting pipe elbows, use saw blade clamping point 2 (see chap. 7.3, p. 24).



**ATTENTION**

### Danger of being injured by sharp and hot cutting edges!

- ⊙ Keep hands **away** from the tools when inserting or replacing the saw blades/additional cutters.
- ▶ Wear safety gloves, safety goggles, hearing protection, and safety shoes.

**Note** Saw blades/bevel cutters can only be fitted or replaced if **no** pipe is clamped in the vice.

- ▶ If necessary, remove the pipe before fitting the saw blade (see chap. 7.4, p. 25).

**ATTENTION**

### Damage to material

- ▶ The saw blade or bevel cutter must be free from chips and dirt.
- ▶ Only use original Orbitalum Tools saw blades and bevel cutters.
- ▶ When employing an additional cutter, only use the special Orbitalum Tools clamp washer, not the normal clamp washer.
- ▶ The labelling on the saw blade should be visible when looking from the front of the machine.
- ▶ Never use a damaged or deformed saw blade or cutter.

### 7.2.1 Inserting the saw blade or bevel cutter

1. Turn the pipe cutter clockwise and upwards by 180°.
2. Tighten the locking screw (2).
3. Clean the saw blade shaft (1) and vicinity.
4. Place onto the shaft (1):
  - Saw blade (3) or bevel cutter and clamping plate (4).
5. Tighten nut (5) counterclockwise (left-hand thread).
6. Loosen the locking screw (2).
7. Turn the pipe cutter clockwise and downwards to its home position.

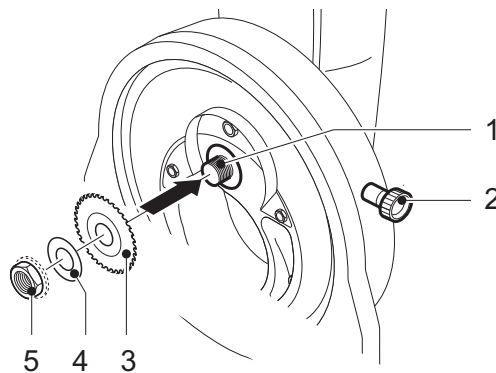

### 7.2.2 Inserting the saw blade and additional cutter

1. Turn the pipe cutter clockwise and upwards by 180°.
2. Tighten the locking screw (2).
3. Clean the saw blade shaft (1) and vicinity.
4. Place onto the shaft (1):
  - Saw blade (3), additional cutter (4) and clamping plate (5).
5. Tighten nut (6) counterclockwise (left-hand thread).
6. Loosen the locking screw (2).
7. Turn the pipe cutter clockwise and downwards to its home position.

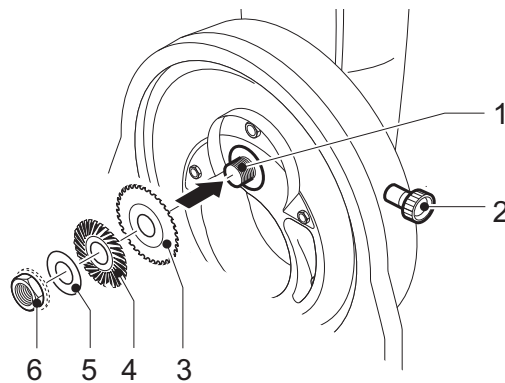

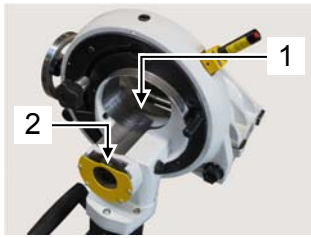

### 7.3 Saw blade clamping point 2: Fitting the saw blade

Only use saw blade clamping point 2 **to cutting pipe elbows**. If you want to cut or bevel pipes, use saw blade clamping point 1 (see chap. 7.2, p. 21).



**ATTENTION**

#### **Danger of being injured by sharp and hot cutting edges!**

- ⊙ Keep hands **away** from the tools when inserting or replacing the saw blades.
- ▶ Wear safety gloves, safety goggles, hearing protection, and safety shoes.

**Note** Saw blades can only be fitted or replaced if **no** pipe is clamped in the vice.

- ▶ If necessary, remove the pipe before fitting the saw blade (see chap. 7.4, p. 25).

#### **ATTENTION** Damage to material

- ▶ The saw blade must be free from chips and dirt.
- ▶ Only use original Orbitalum Tools saw blades.
- ▶ The labeling on the saw blade must always face the pipe cutter. Observe assembly instructions of saw blade guard.
- ▶ Never use damaged or deformed saw blades.

#### 7.3.1 Inserting the saw blade

1. Clean the saw blade shaft (1) and vicinity.
2. Place onto the shaft (1):
  - Saw blade (3) and clamping plate (4).
3. Tighten nut (5) clockwise.

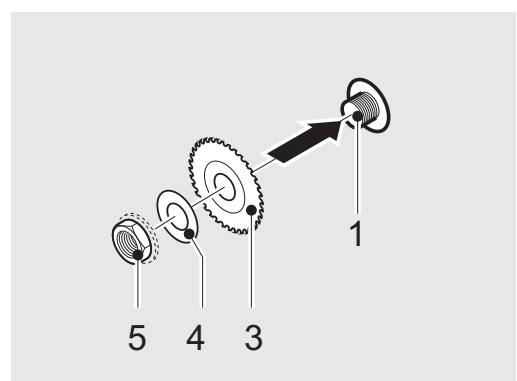
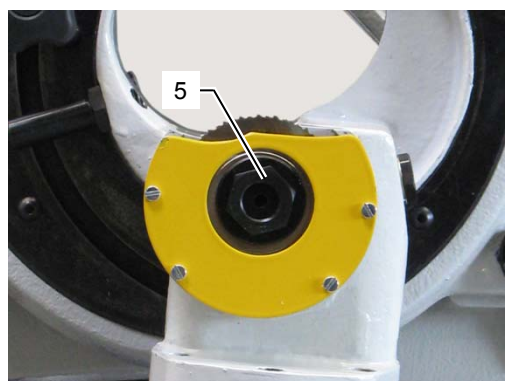

## 7.4 Adjusting the pipe dimension

**Note** The steps for adjusting the pipe dimension are identical for both saw blade clamping points.

### 7.4.1 Setting the pipe dimension with a scale (2)

1. Loosen the star knob (1).
2. Select the pipe dimension on the scale (2).
3. Slide the star knob (1) in the direction of the arrow to the desired pipe dimension.
4. Tighten the star knob (1).

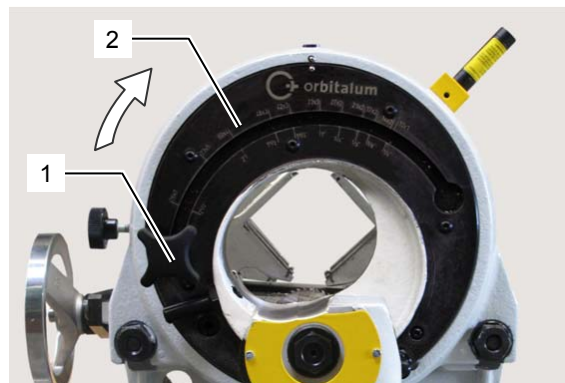

### 7.4.2 Setting the pipe dimension without a scale (2)

1. Place the pipe in the vice.
2. Slide the pipe forwards until it is close to the saw blade.
3. Clamp the pipe in the vice.
4. Loosen the star knob (1) and set to "2 ½ inch". Do not tighten.
5. Raise the motor of the pipe cutter in the direction of the arrow as if to saw until the teeth of the saw blade protrude approx. 1.5 mm/0.059 inch (approx. height of saw blade teeth) into the center of the pipe.
6. Tighten the star knob (1).

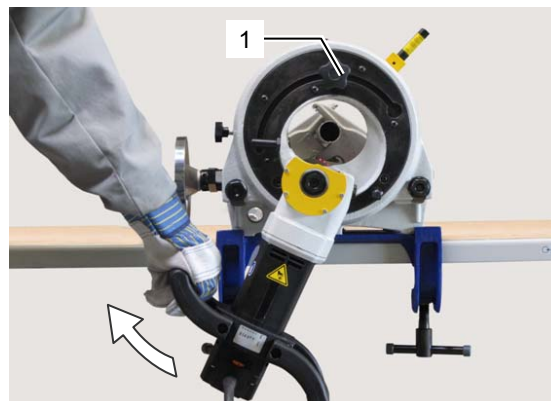

### 7.4.3 Setting the pipe dimension when using an additional cutter

Steel pipes with a wall thickness of 7 mm (0.276 inch) can be simultaneously cut and beveled.

1. Place the pipe in the vice.
2. Slide the pipe forwards until it is close to the additional cutter.
3. Clamp the pipe in the vice.
4. Loosen the star knob (1) and set to 2 ½ inch. Do not tighten.
5. Raise the motor of the pipe cutter until the bevel cutter covers the pipe wall.
6. Tighten the star knob (1).

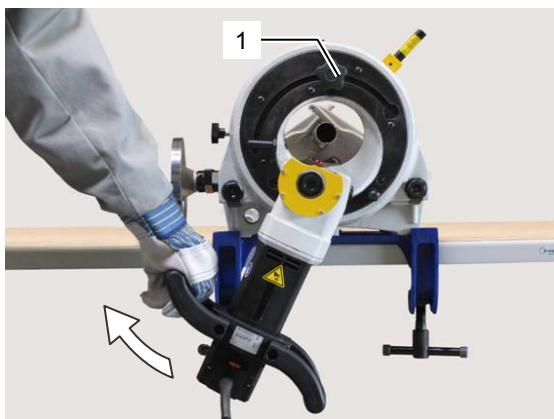

7. Perform a test bevel and check the bevel (see chap. 8.3, p. 28).

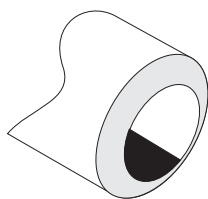

*Bevel OK*

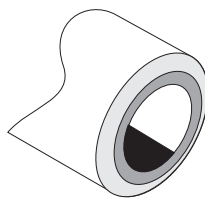

*Move the star knob (1)  
slightly to the right*

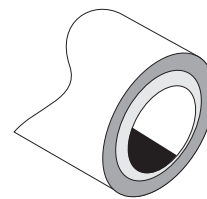

*Move the star knob (1)  
slightly to the left*

## 8 Processing Pipes



### Danger of death by electric shock!

- ▶ Prior to assembly, dismantling, maintenance and adjustment work, disconnect the GFX 3.0 from the power supply and let it come to a complete stop.



### Electric shock due to shunting of armature shaft isolation!

Danger of death.

- ⊙ **Do not** connect anything other than the stipulated safety equipment between the socket and the machine.
- ▶ Connect to a RCD (residual circuit device).



### Electric shock from excess lubricant!

When the slide housing is rotating, excess lubricant can get into the motor unit.

- ▶ Remove excess lubricant from the machine after every step.

### Attention Tool damage

A pipe that is not sawn off at right-angles can damage the tool if the distance between the cutting edge and the pipe end is too small.

- ▶ Before switching on the GFX 3.0, ensure that there is sufficient distance between the cutting edge and the pipe end.

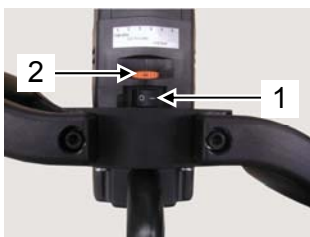

### 8.1 Shutdown function (even in an emergency)

- ▶ Activate by switching the ON/OFF toggle switch (1). If the ON/OFF toggle switch (1) fails to work, remove the plug from the socket or vacate the danger zone as quickly as possible.

### 8.2 Selecting the speed levels

Pipe material	Controller setting (2)	Spindle speed (rpm)
High-alloy/high-quality steels	1 -3	30 - 98
Low-alloy/high-quality steels	3 - 5	98 - 166
Construction steel	5 - 6	166 - 200

**IMPORTANT** Select a low speed for large pipe diameters and wall thicknesses!

### 8.3 Cutting pipes

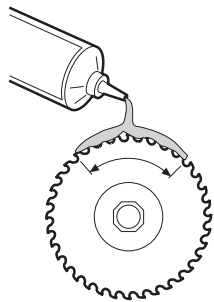

1. Fit saw blade and/or bevel cutter (saw blade clamping point 1, see chap. 7.2, p. 21; saw blade clamping point 2 to cutting pipe elbows, see chap. 7.3, p. 24).
2. Adjust the bevel cutter to the pipe dimension (see chap. 7.4, p. 25).
3. Connect pipe cutter to power supply.
4. Apply saw blade lubricant to teeth of saw blade.  
Repeat lubrication every 3 cuts.

#### Important

Only use saw blade lubricant/paste (no oils) from Orbitalum Tools (e.g. GF LUB or GF TOP). Keep the machine clean. Always remove lubricant residues from the machine.

5. Place the pipe in the vice (2).
6. Slide pipe to the desired cut-off point; mark the cut-off point on the pipe using the line laser (1).
7. Clamp the pipe in the vice using the hand wheel (3).

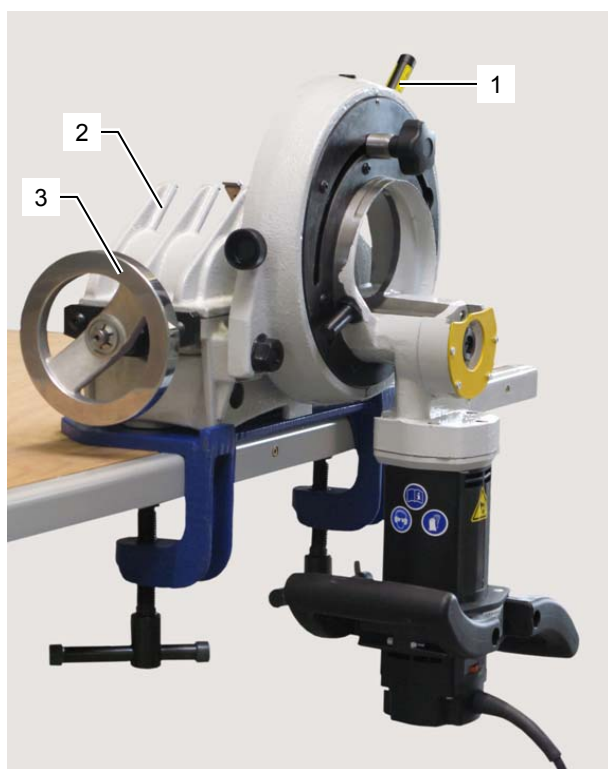



**ATTENTION****Tipping and snapping off of pipes!**

Danger of crushing.

- ▶ Support pipes using the pipe holder.

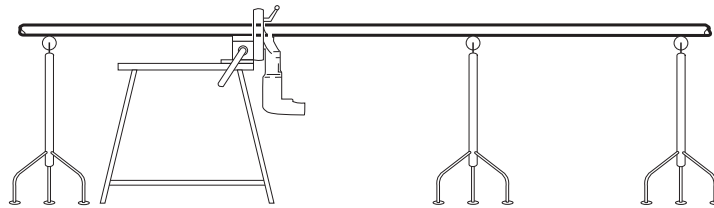

8. Switch the saw motor on at the ON/OFF switch (4).
9. Set the desired speed level using the speed regulator (5) (for standard values, see chap. 8.2, p. 27).
10. Carefully turn the pipe cutter in a clockwise direction until the pipe wall has been pierced through.
11. Continue turning rapidly until the pipe has been cut off and the marks (6) are aligned on the slide housing and body.

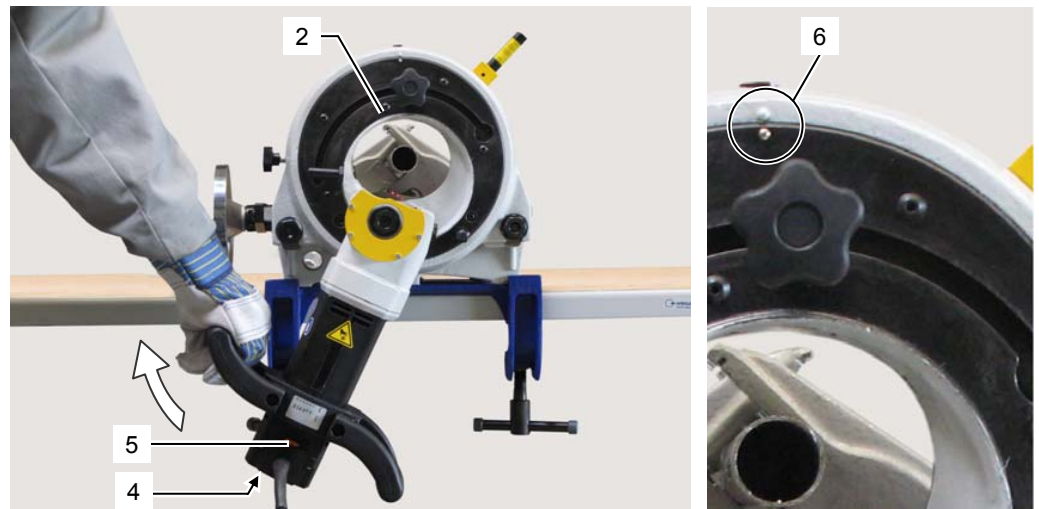

12. Turn the pipe cutter back to its home position.
13. Switch the saw motor off again at the ON/OFF switch (4).

**For continuous operation**

At the end of shifts or during long breaks, loosen the blade clamping nut to reduce the pressure on oil seals etc. Ensure that the nut is retightened before cutting commences.

**8.4 Beveling pipes**

The necessary work steps for beveling pipes are identical to chap. 8.3, p. 28.

## 8.5 Cutting and beveling pipe simultaneously

The necessary work steps for simultaneously cutting and beveling are identical to chap. 8.3, p. 28. The pipe cutter however must revolve much slower around the pipe than when cutting, since two tools are being used at the same time.



## 8.6 Cutting pipe elbows

Pipe elbows are cut at saw blade clamping point 2 (Saw blade assembly, see chap. 7.3, p. 24). The necessary work steps for cutting pipe elbows are identical to chap. 8.3, p. 28.

## 9 Maintenance

The pipe cutter GFX 3.0 was designed for a long service life and low maintenance.

**Note** Should the machine not work as described above, it must be sent to an authorized Orbitalum service Centre that is equipped for VDE testing.



### Fatal electric shock as a result of poor electrical assembly!

- ⊙ Do not meddle with the machine electrics
- ▶ Send the machine to an authorized service center that is equipped for VDE testing.



### Danger of death by electric shock!

- ▶ Before performing any maintenance work, remove the mains plug and allow the machine to run to a stop.

The following maintenance instructions must be observed:

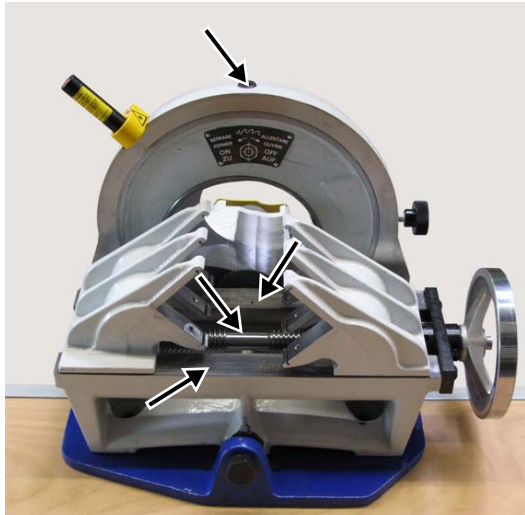
Time	Activity
Weekly	<ul style="list-style-type: none"> <li>▶ Remove the saw blade and use the brush to remove any saw chips.</li> <li>▶ Lubricate the 4 points indicated by the arrows.</li> <li>▶ Check the oil level of the gear on the oil indicator and fill up if necessary.</li> </ul> 

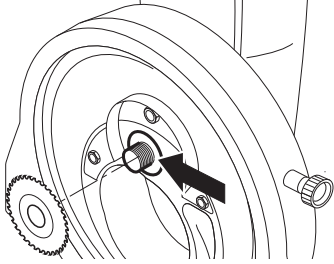
Time	Activity
When cleaning and when changing tools	<ul style="list-style-type: none"><li data-bbox="432 282 1457 394">⊘ Do <b>not</b> use compressed air to clean the area at the end of the shaft (marked with an arrow) as the rotary shaft seal may otherwise be damaged by chips.</li><li data-bbox="432 416 1457 450">▶ Use a cloth or brush to clean the end of the shaft.</li></ul> 

## 10 What to do if?

### 10.1 Troubleshooting

The following table gives you the possible causes while troubleshooting.

Problem	Possible cause	Remedy
The pipe cutter will not turn.	The locking screw is tight.	▶ Loosen the locking screw.
	Incorrect pipe dimension.	▶ Set the pipe dimension correctly.
The saw blade is not cutting and is slipping through.	The nut on the saw blade shaft is not tight enough.	▶ Tighten the nut.
The saw blade is not cutting.	The saw blade has been inserted the wrong way round.	▶ Insert the saw blade so that the labeling on the saw blade faces the pipe cutter.
The pipe is not cut concentrically.	The pipe cutter has been incorrectly flanged. The flange surfaces are contaminated.	▶ Remove the pipe cutter, clean the fixing parts and flange surfaces, reflare the saw.
The pipe is not cut.	Pipe dimension not correctly set.	▶ Adjust the bevel cutter to the pipe dimension (see chap. 7.4, p. 25).
	The clamping lever is not tightened.	▶ Tighten the clamping lever.
The motor does not start.	The auto startup inhibitor is active because the On switch is locked.	▶ Release the locking button and press the On switch again.

### 10.2 Servicing/customer service

For ordering spare parts, refer to the separate spare parts list.  
For troubleshooting, please contact the branch responsible directly.

Please provide the following details:

- Machine type: **GFX 3.0**
- Machine no.: *(see type plate)*

# 11 EG Declaration of Conformity



**EG – Konformitätserklärung**  
**Declaration of conformity**  
**Dichiarazione di conformità**  
**Déclaration de conformité**  
**Declaración de conformidad**

**Orbitalum Tools GmbH**  
 Josef-Schüttler-Straße 17  
 78224 Singen, Deutschland  
 Tel.: +49 (0) 77 31 792-0  
 Fax: +49 (0) 77 31 792-524

As in appendix II A of the EC Machinery Directive 2006/42/EC and the EMC Directive 2004/108/EC

Die Bauart der Maschine: The following product: Il seguente prodotto: Le produit suivant: El producto siguiente:	Pipe cutting and beveling machine <b>GFX 3.0</b>
Seriennummer: Series number: Numero di serie: Nombre de série: Número de serie:	
Baujahr / Year / Anno / Année / Año:	

ist entwickelt, konstruiert und gefertigt in Übereinstimmung mit folgenden EG-Richtlinien:  
 was designed, constructed and manufactured in accordance with the following EC guidelines:  
 è stata progettato costruito e commercializzato in osservanza delle seguenti Direttive:  
 a été dessiné, produit et commercialisé selon les Directives suivantes:  
 ha sido proyectado construido y comercializado bajo observación de las siguientes Directivas:

**EG-Maschinen-Richtlinie 2006/42/EG (MaschR)**  
**EMV-Richtlinie 2004/108/EG**

Folgende harmonisierte Normen sind angewandt:  
 The following harmonized norms have been applied:  
 Le seguenti norme armonizzate ove applicabili:  
 Les normes suivantes harmonisées où applicables:  
 Las siguientes normas armonizadas han sido aplicadas:

**EN ISO 13849-1 : 2008**  
**EN ISO 13849- 2 : 2008**  
**EN ISO 12100-1: 2003**  
**EN ISO 12100-2: 2003**  
**EN ISO 14121-1: 2007**  
**EN 1037: 2008**  
**EN 60745: 2009**  
**EN 61029-1: 2009**

Singen, Jan. 22, 2010

Markus Tamm  
CEO

Hasan Caglar  
Process division head



**Orbitalum Tools GmbH**

**Sales Contact:**

Tel. +49 (0) 77 31 / 792-0

Fax +49 (0) 77 31 / 792-524

[tools@orbitalum.com](mailto:tools@orbitalum.com)

[www.orbitalum.com](http://www.orbitalum.com)

An ITW Company

**Plant:**

Division Orbitalum

Josef-Schüttler-Straße 17

78224 Singen

Germany

790 144 762\_00/02 (08.10)

© Orbitalum Tools GmbH

D-78224 Singen 2010

Printed in Germany